

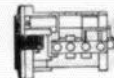

15

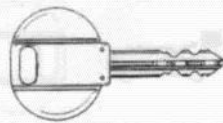
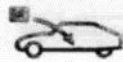

XM
844-1/3

1

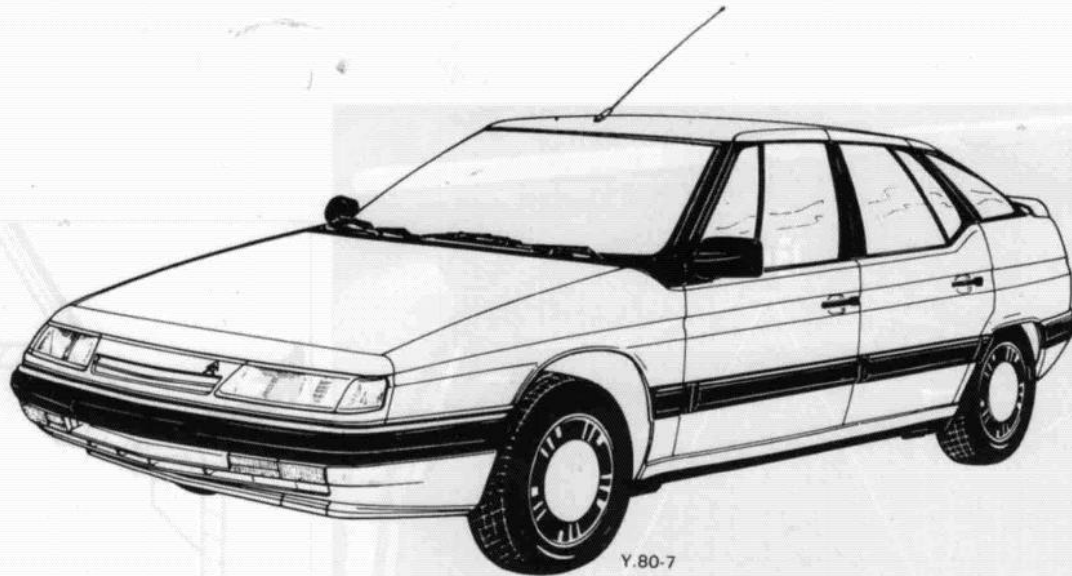

Y.80-7

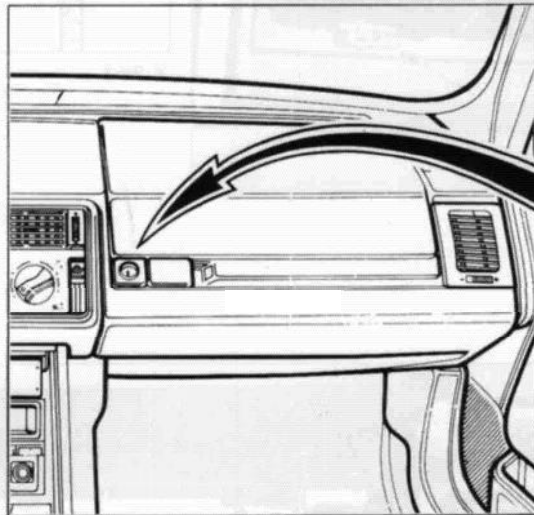

Y.95-3

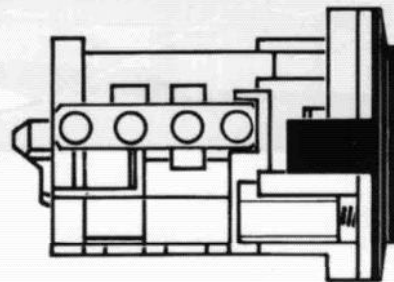

Y.86-1

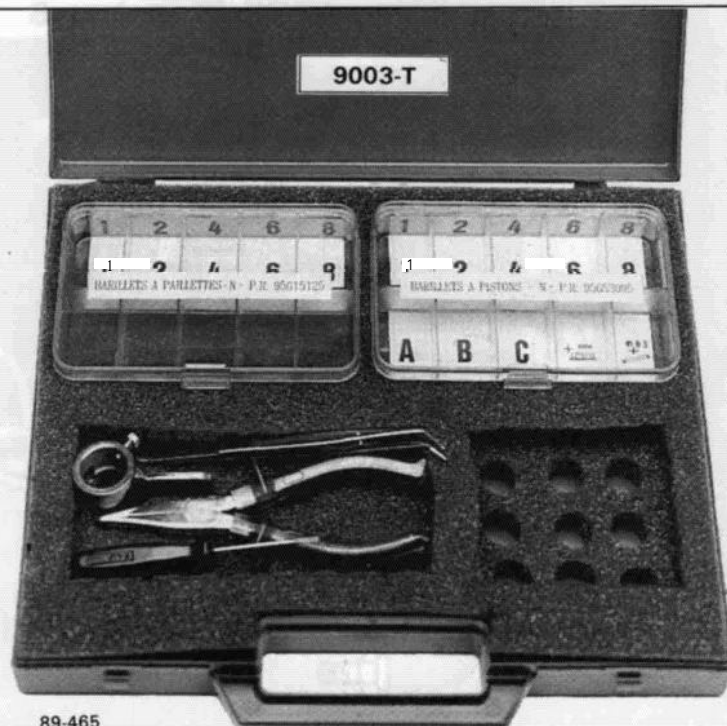

89-465

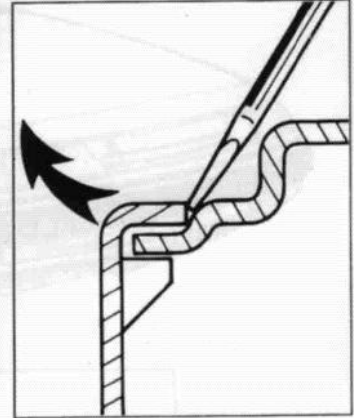
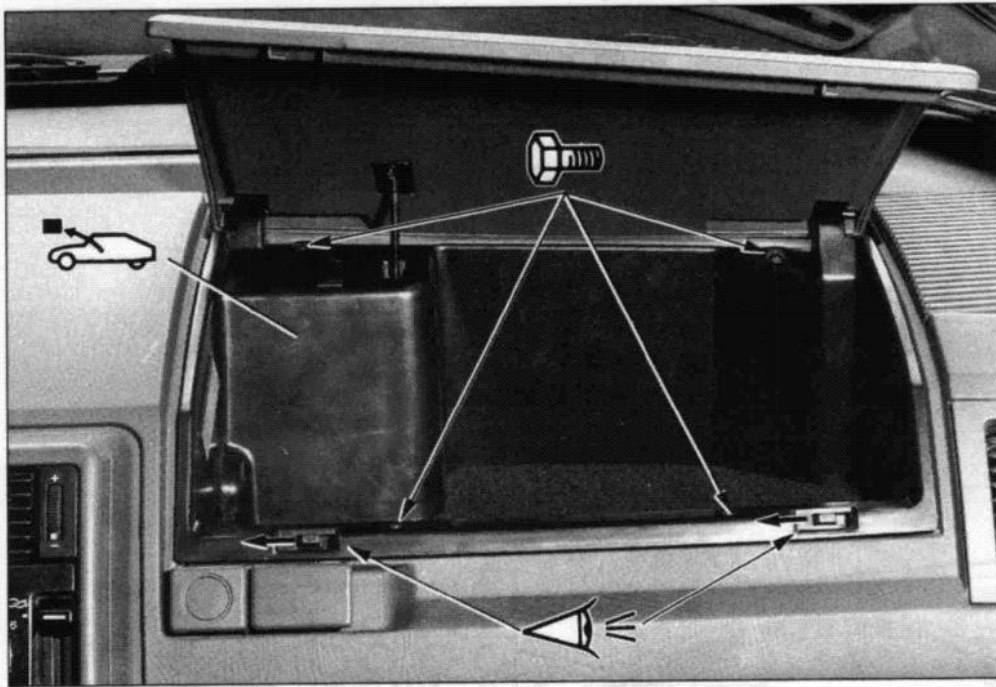
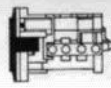
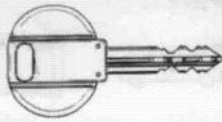
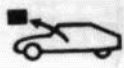

Y. 98-3

89-669

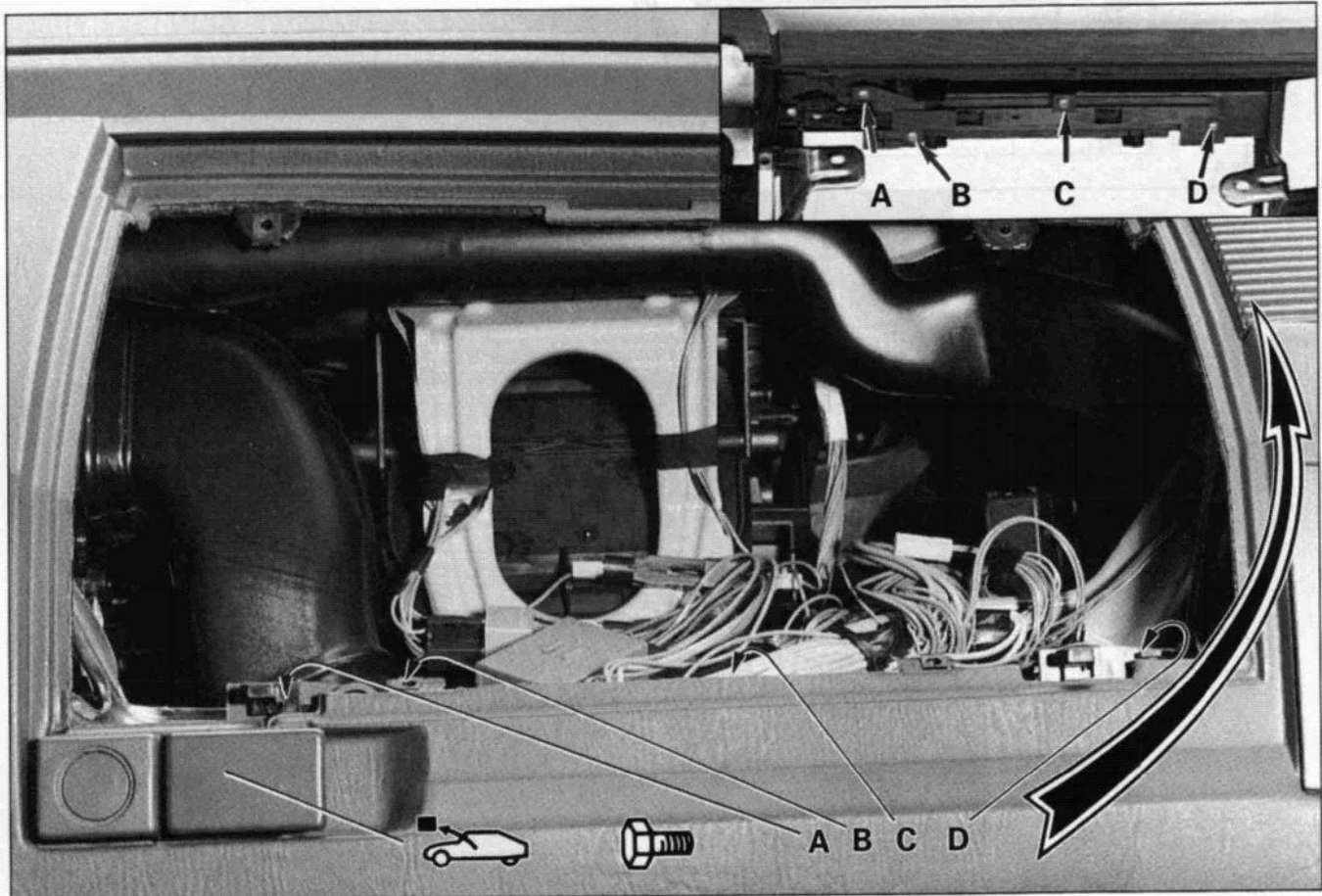

39-667 89-4231



15

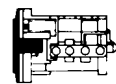
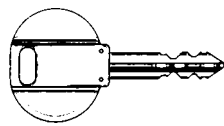
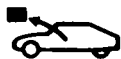

XM
844-113

3

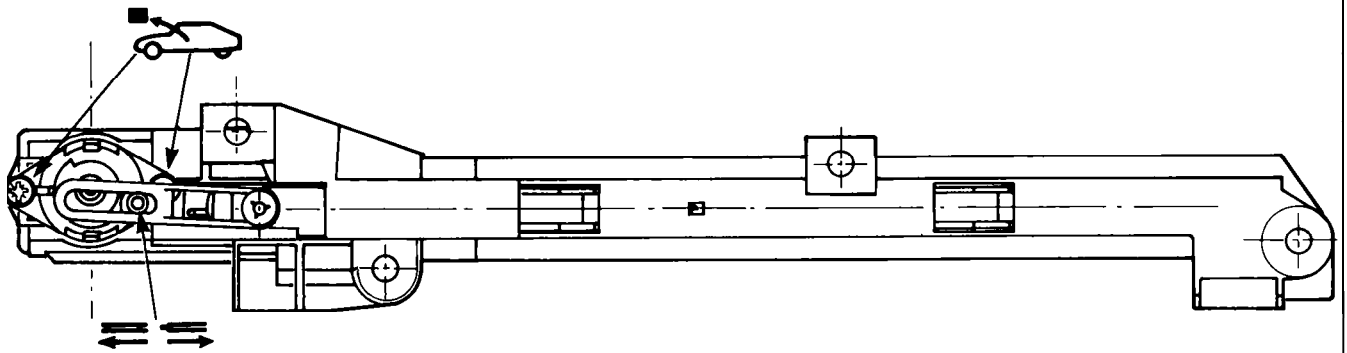

Y.95-2

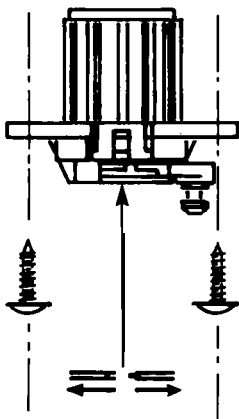

Y.95-2

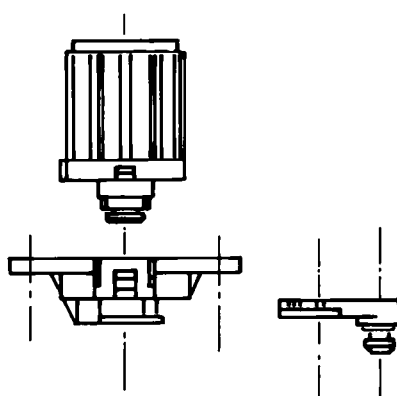

Y.95-2

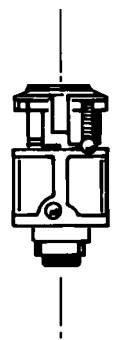

Y.95-2

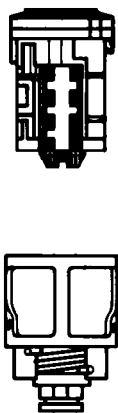

Y.86-2

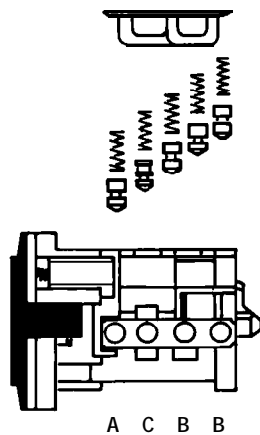

Y.86-1



XM 844-311

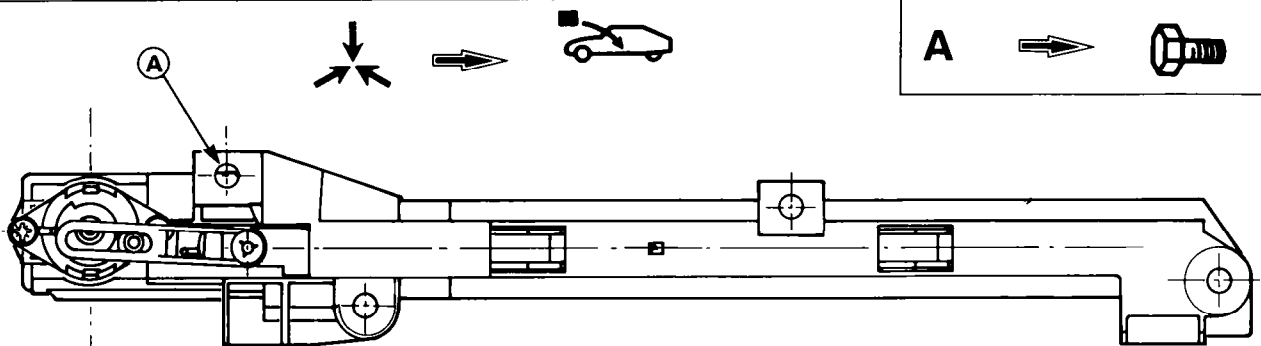

Y.86-2