

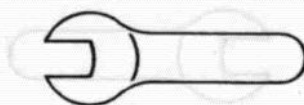

5



XM  
330-000/2

1

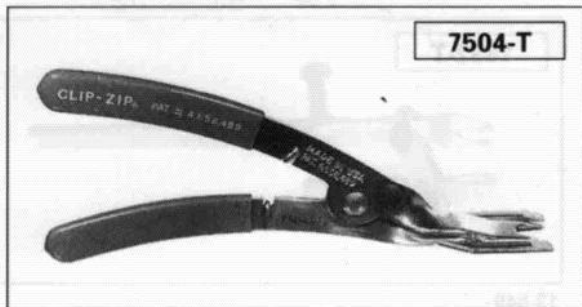

89-228

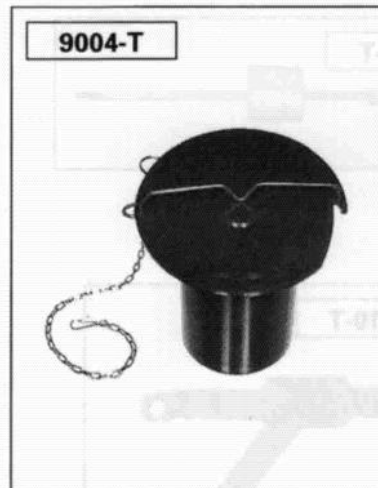

89-708

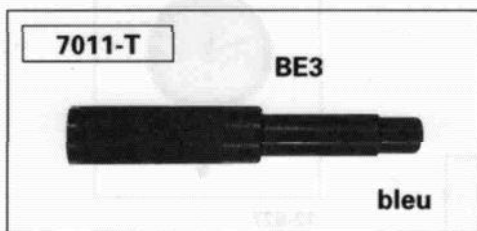

84-354



81-813

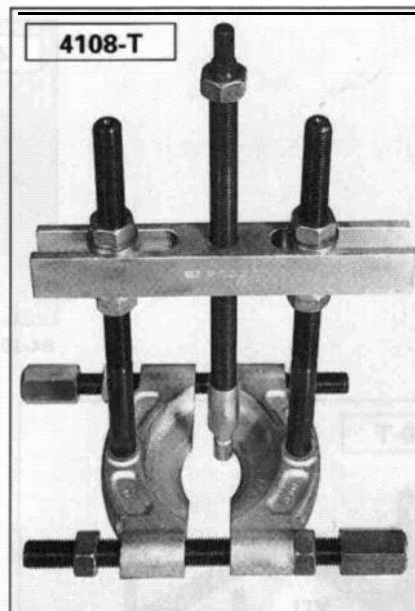

83-120

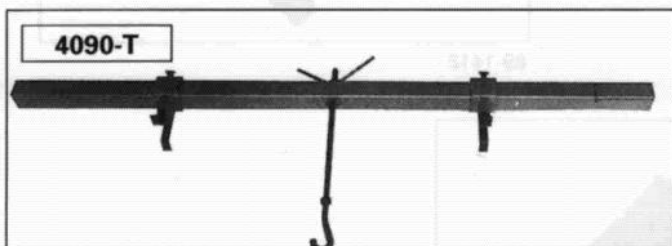

86-850

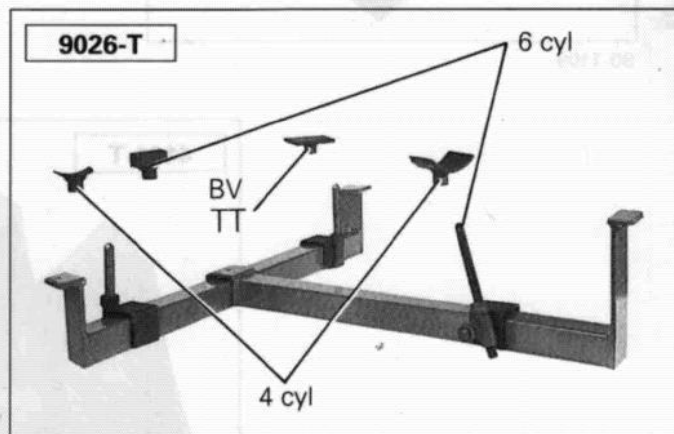

90-50

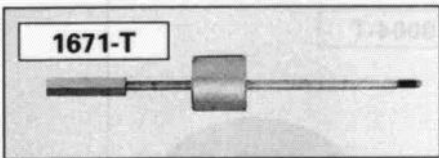
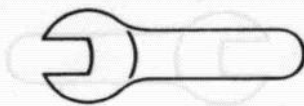

**1671-T**

13-551

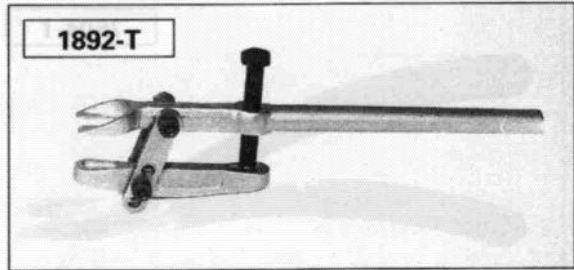

**1892-T**

13-549

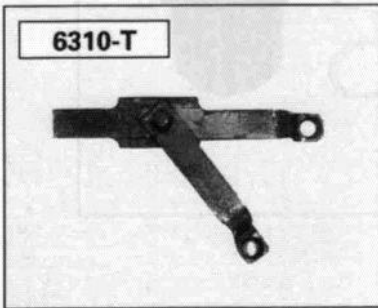

**6310-T**

13-723

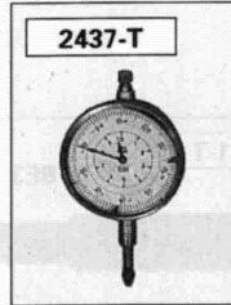

**2437-T**

12-827

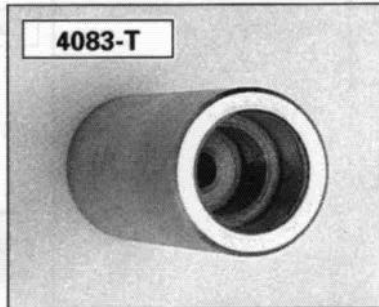

**4083-T**

84-795

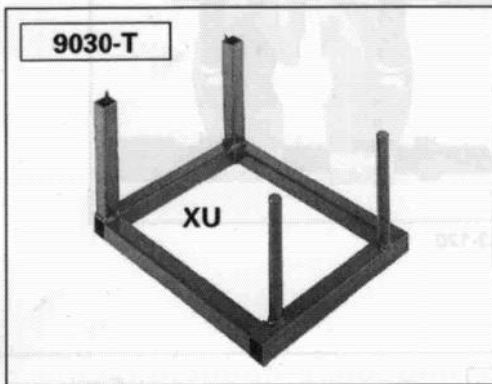

**9030-T**

90-1109

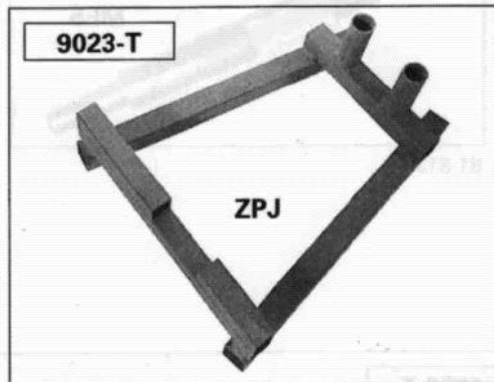

**9023-T**

89-1412

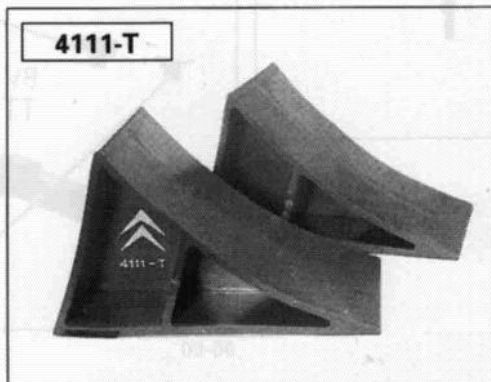

**4111-T**

89-1307



5

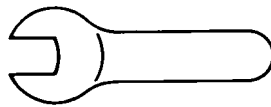





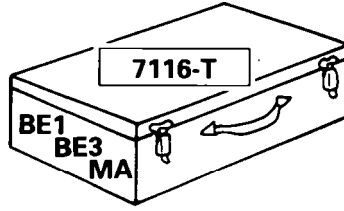



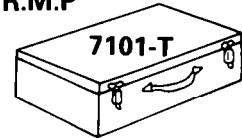

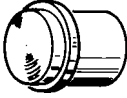
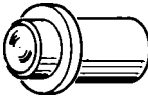















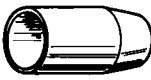



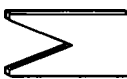
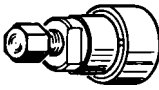

XM  
330-000/2

3



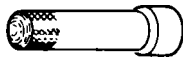

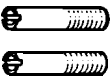

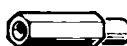



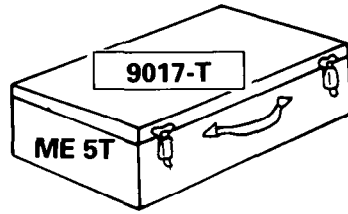
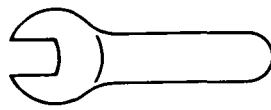













R.M.P

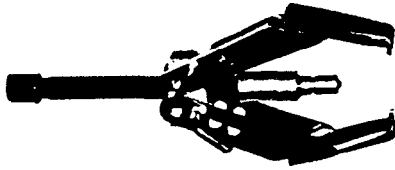

 7101-T.A	 7101-T.O	 7114-T.W
 7101-T.B	 7101-T.P	 7114-T.X
 7101-T.C	 7107-T.Q	 7115-T
 7101-T.D	 7107-T.R	 A
 7101-T.E	 7107-T.S	 B
 7101-T.F	 4508-T.T	 C
 7101-T.G	 4508-T.U	 D
 7101-T.H	 4508-T.V	 E
 4508-T.J'	 7109-T.S	 F ∅ 4,8 Lq. 13
 7101-T.K	 7113-T.S	 8.0902 K
 7101-T.L	 7113-T.W	 8.0313-T.M
 7101-T.M	 7113-T.X	
 7101-T.N	 7113-T.X	

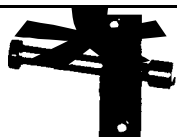
MR 630-69/32



	A		M
	B		N
	C		P
	D		Q
	E		4507-T - C
	F		6336-T
	G		6339-T
	H		
	J		6317-T
	K		6318-T
	L		7113-T - X
			80902 K



5

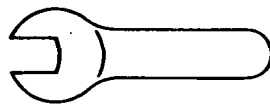

**XM**  
330-000/2

5

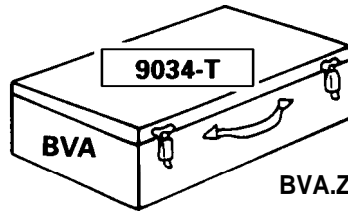

BVA.ZF.4 HP . . .

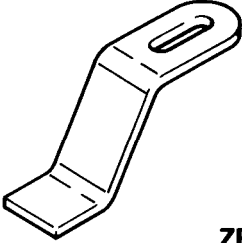
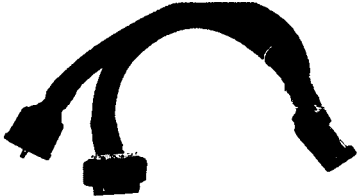
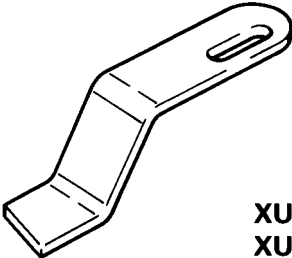
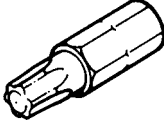
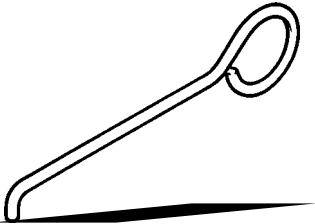
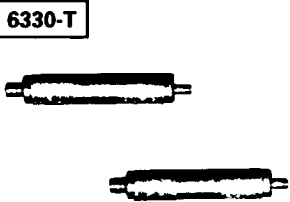
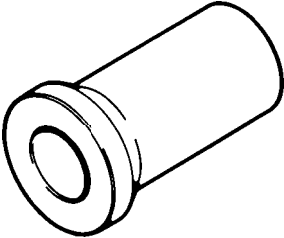
 <p><b>A</b></p> <p>ZPJ</p>	 <p><b>E</b></p>
 <p><b>B</b></p> <p>XU . . XUD .</p>	 <p><b>F</b></p> <p>X. 27</p>
 <p><b>C</b></p>	 <p><b>G</b></p> <p>6330-T</p>
 <p><b>D</b></p>	<p>MR 630-69/35</p>